

SG60 GYRO STABILIZER

Smartgyro SG60 is the gyro stabilizer of choice for boats from 55-65 ft. Ideal for both new builds and refit installations, the stabilizer can be fully serviced on-board the vessel without the need to lift out for maintenance, ensuring significant time and cost savings.



TECHNICAL SPECIFICATIONS

Maximum Rated speed	5.500 RPM	Operating AC power	2.4 - 4.0 kW *
Angular momentum at max. rated speed	12.500 Nms	DC power ("Spool-up" and operating)	220 W (including display)
Anti-rolling torque at max. rated speed	25.000 Nm	Sea water supply	15 (min) - 30 (max) LPM [4 (min) - 8 (max) GPM]
"Spool-up" time to max. rated speed	45 minutes	Operating temperature	0 - 60 °C [32 - 140 °F]
"Spool-up" time to stabilization	25 minutes (55% of rated speed)	Envelope dimensions	1.08 x 1.11 x 0.87 m [42.4 x 43.7 x 34.3 in]
Input voltage (AC)	220V nominal 50/60 Hz, single phase	Weight	910 kg [2006 lbs]
Input voltage (DC):	24 Vdc	Noise output	62 - 64 dBC @ 1 meter
"Spool-up" AC power	4.5 kW		

*sea state dependent

NOTE: All data subject to change without notice. Text and illustrations are not binding.

PORT VIEW

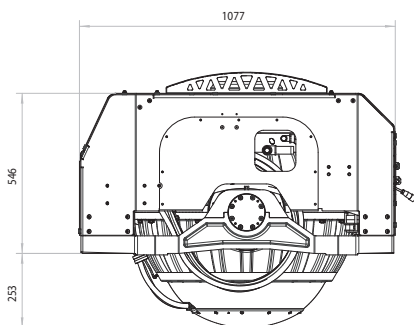

TOP VIEW

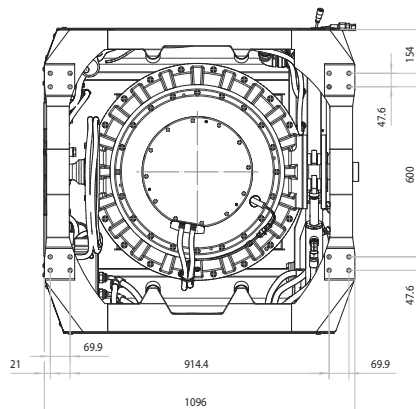

FRONT VIEW

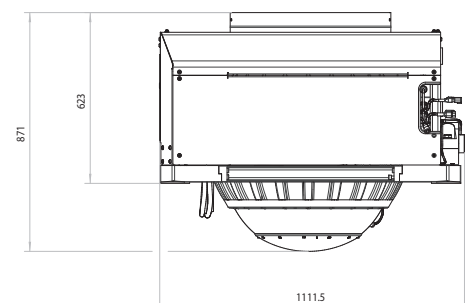

Dimensions in mm