

# Smart Throttle User Manual



## Acknowledgement

---

Thanks for choosing ePropulsion products, your trust and support in our company are sincerely appreciated. We are dedicated to providing high-performance electric outboards, electric outboards, sup/kayak motors, reliable lithium batteries and accessories.

Welcome to visit [www.epropulsion.com](http://www.epropulsion.com) and contact us if you have any concerns.

## Using This Manual

---

Before use of the product, please read this user manual thoroughly to understand the correct and safe operations. By using this product, you hereby agree that you have fully read and understood all contents of this manual. ePropulsion accepts no liability for any damage or injury caused by operations that contradict this manual.

Due to ongoing optimization of our products, ePropulsion reserves the rights of constantly adjusting the contents described in the manual. ePropulsion also reserves the intellectual property rights and industrial property rights including copyrights, patents, logos and designs, etc.

This manual is subject to update without prior notice, please visit our website [www.epropulsion.com](http://www.epropulsion.com) for the latest version. If you find any discrepancy between your products and this manual, or should you have any doubts concerning the product or the manual, please visit [www.epropulsion.com](http://www.epropulsion.com).

ePropulsion reserves the rights of final interpretation of this manual.

This manual is multilingual, in case of any discrepancy in the interpretation of different language versions, the English version shall prevail.

## Symbols

---

The following symbols will help to acquire some key information.



Important instructions or warnings



Useful information or tips

# Product Identification

The picture below indicates the serial numbers of Smart Throttle. Please note the position of the serial numbers and record them for access to warranty service and other after-sale services.

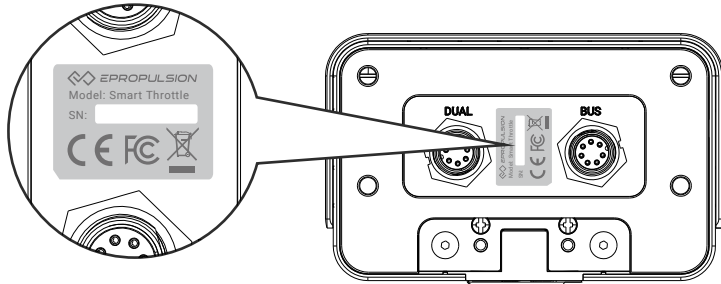

Figure 0-1

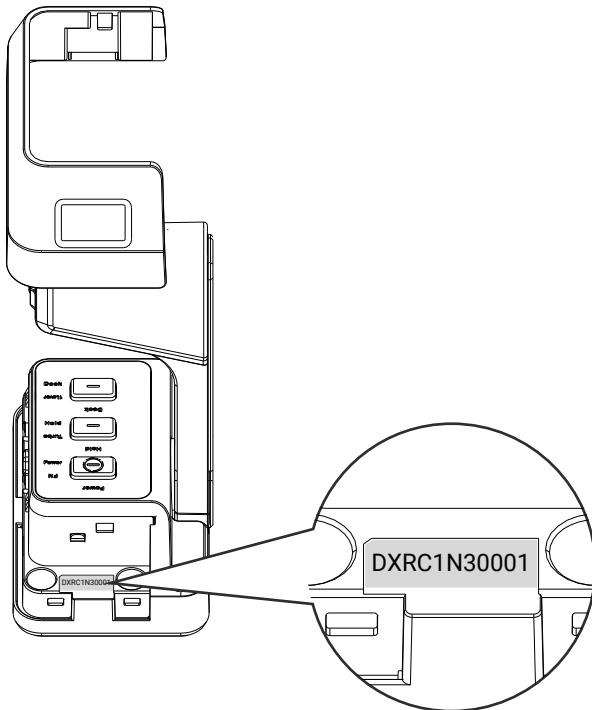

Figure 0-2





# Table of Contents

- Acknowledgement**..... 1
- Using This Manual**..... 1
- Symbols** ..... 1
- Product Identification**..... 2
- 1 Product Overview** ..... 4
  - 1.1 In the Package ..... 4
  - 1.2 Specifications ..... 5
  - 1.3 Important Notes ..... 5
  - 1.4 Declaration of Conformity..... 6
- 2 Connection** ..... 7
- 3 Mounting** ..... 8
  - 3.1 Single-Throttle (Top Mount)..... 8
  - 3.2 Single-Throttle (Side Mount)..... 9
  - 3.3 Dual-Throttle (Top Mount) ..... 10
- 4 Use of Kill Switch**..... 12
- 5 Function Description**..... 13
- 6 Disposal and environment**..... 14
- 7 Warranty** ..... 15
  - Out of Warranty ..... 16
  - Limited Warranty Claim Procedures..... 17

# 1 Product Overview

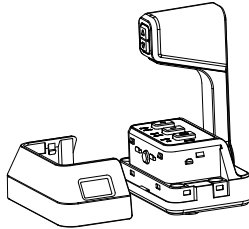
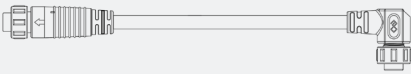
ePropulsion Smart Throttle is connected to the motor system by wire, starting and stopping the motor, adjusting the speed of the motor, switching between different control modes, etc.

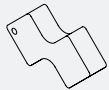
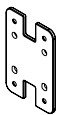

## 1.1 In the Package

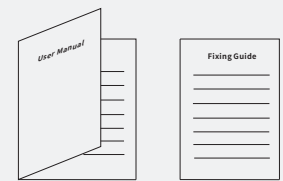
Items	Qty./Unit	Figure
Smart Throttle	1	
Communication cable	1	
Kill switch	2	
Floating	1	
Dual installation bracket	1	
Side mount bracket	1	
Screws and nuts	1 sets	

Items	Qty./Unit	Figure
User manual, fixing guide	1 Set	

## 1.2 Specifications

Weight	Communication	Communication distance	Dimensions
540g	Wired	≤15m	Single-throttle: 127x80x165 mm Dual-throttle: 127x169x165 mm

-  Other accessories are not included in the package. Users can buy official accessories provided by ePropulsion from ePropulsion authorized dealers.
-  Save ePropulsion original package for transport and storage.

## 1.3 Important Notes

1. Only adults who have fully read and understood this manual are allowed to operate this product.
2. Check the function of the Smart Throttle before use.
3. Make sure the Smart Throttle is properly installed before use.
4. After installing the Smart Throttle correctly, please attach the protective cover.

## 1.4 Declaration of Conformity

We Guangdong ePropulsion Technology Co., Ltd., hereby, declares that this equipment is in compliance with the applicable Directives and European Norms, and amendments. The full text of the EU declaration of conformity is available at the following internet address: <http://yachter123.com/sy>

### Object of the Declaration:

Product: Smart Throttle

Model: Smart Throttle



**Company Name:** Guangdong ePropulsion Technology Limited

**Address:** Room 801, Building 1, 11 University Avenue, Songshan Lake, Dongguan, Guangdong Province, China

### The object of the declaration is in conformity with the following directives:

Electromagnetic Compatibility (EMC) Directive      2014/30/EU

### Applied Standards:

EN61000-6-2: 2005

EN61000-6-3: 2007+A1:2011

This device complies with part 15 of the FCC Rules: Operation is subject to the following two conditions:

1. This device may not cause harmful interference and,
2. This device must accept any interference received, including interference that may cause undesired operation.

**Signature:** 陶师正

Shizheng Tao, Chief Executive Officer & Cofounder of  
Guangdong ePropulsion Technology Limited

## 2 Connection

Please follow the figure below to connect the throttle to the motor by a communication cable. Please connect the BUS connector to the motor.

When used as the dual remote control, please connect the DUAL connector of two Smart Throttles by a communication cable.

 When used as the dual-throttle, the throttle whose BUS connector is connected to the motor is the master.

Connect to the other throttle  
and use as dual-throttle

Connect to system

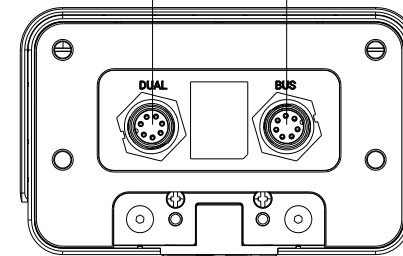



Figure 2-1

## 3 Mounting

 Before mounting the Smart Throttle, it is recommended to connect the entire equipment first, check whether it works well, and whether the communication cable is properly connected. For the connection method of the communication cable, please refer to 2 *Connection*.

### 3.1 Single-Throttle (Top Mount)

1. Reserve the position of the throttle in the console of the boat, find the position of the four fixed bolts with the help of the fixing guide and punch the hole with a 5mm drill.

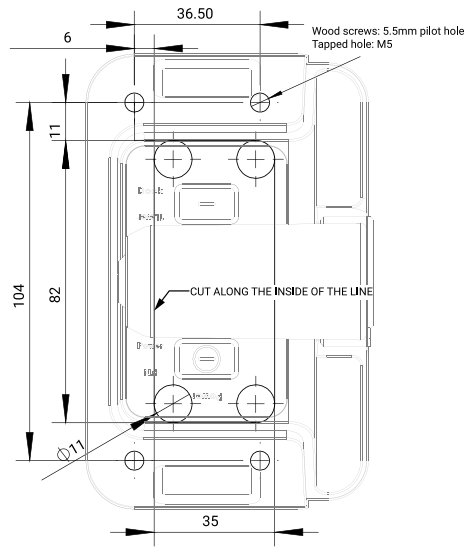

Figure 3-1

2. Align the throttle with the four holes, paying attention to the installation direction. Tighten the bolts after installing the throttle.
3. Attach the decorative cover to the throttle and press it from the four corners to hold it in place.

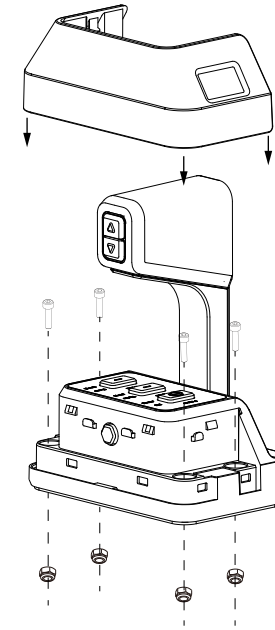

Figure 3-2

### 3.2 Single-Throttle (Side Mount)

1. Reserve the position of the throttle in the console of the boat, find the position of the four fixed bolts with the help of the fixing guide and punch the hole with a 5mm drill.
2. Install the Smart Throttle on the side mount bracket and fix it with bolts.

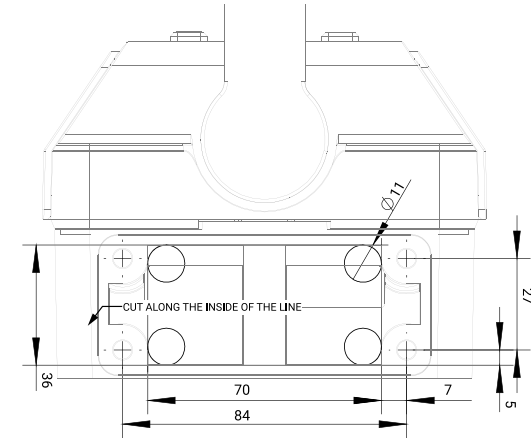

Figure 3-3

- Align the throttle with the four holes of the side mount bracket, paying attention to the installation direction. Tighten the bolts after installing the throttle (figure 3-3).

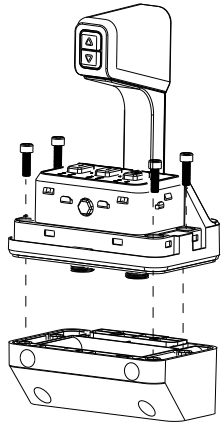

Figure 3-3

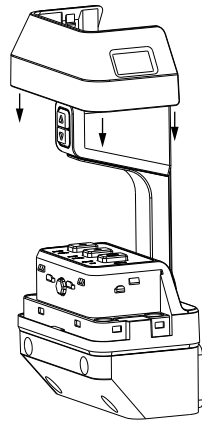

Figure 3-4

- Attach the decorative cover to the throttle and press it from the four corners to hold it in place (figure 3-4).
- Align the side mount bracket with the four holes, and pay attention to the installation direction. Install the side mounting bracket and tighten the bolts.

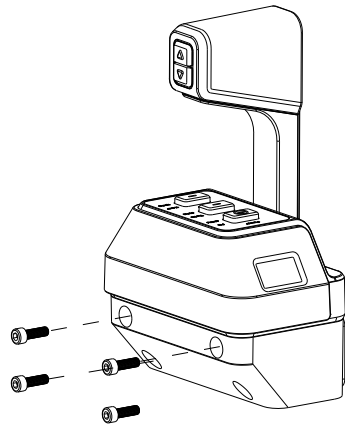

Figure 3-5

### 3.3 Dual-Throttle (Top Mount)

- Reserve the position of the throttle in the console of the boat, find the position of the eight fixed bolts with the help of the fixing guide and punch the hole with a 5mm drill.

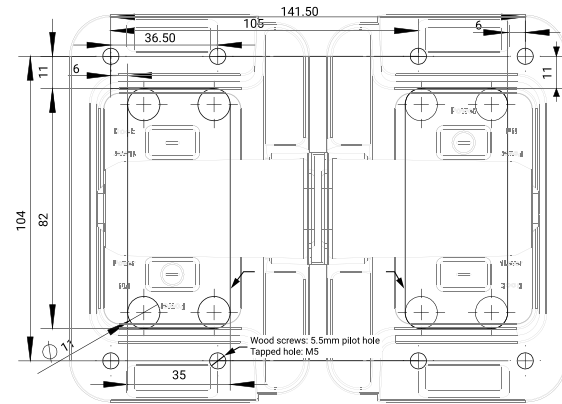

Figure 3-6

- Align the throttles with the four holes of the dual installation bracket and pay attention to the installation direction. Install the throttles with the bracket and tighten the bolts (figure 3-7).

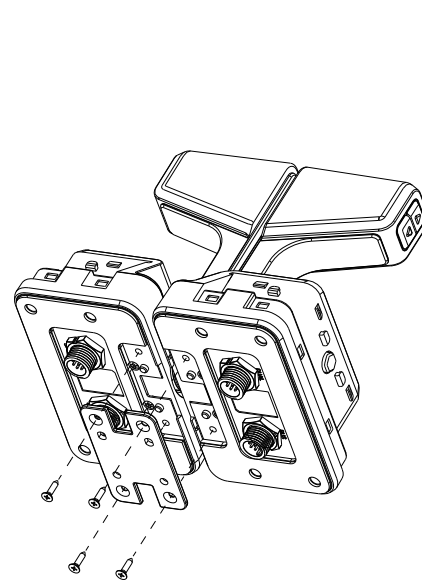

Figure 3-7

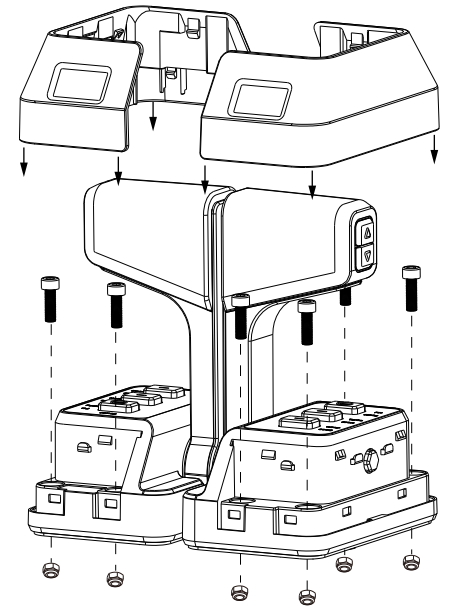

Figure 3-8

- Align the dual-throttle with the eight holes, and pay attention to the installation direction. Install the two throttles and tighten the bolts (figure 3-8).

## 4 Use of Kill Switch

---

Locate the kill switch to the right place on the Smart Throttle and tie its lanyard to your wrist or life jacket. Stop the outboard in emergency by detaching the kill switch.

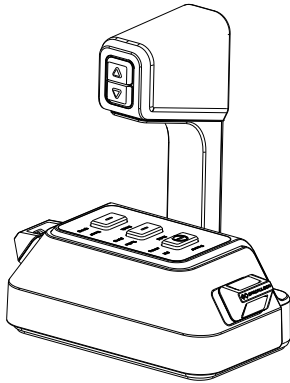

Figure 5-1

- 💡 Please place a kill switch on either side of the Smart Throttle to start the motor.
- 💡 Please remove the kill switch after the machine is turned off.
- 💡 After connecting the machine and the battery, please attach the kill switch properly before turning on the machine, otherwise the machine will not work normally.
- 💡 The kill switch generates magnetic field. Keep it 50cm / 20inches away from medical implants like pacemakers and magnetic cards (e.g. credit card) as well as other magnetic media.
- 💡 The magnetic field of the kill switch may interfere with some electronic instruments. Keep it away from these electronic instruments.

## 5 Function Description

---

💡 Please read the user manual of the motor.



## 6 Disposal and environment

All products bearing this symbol are waste electrical and electronic equipment (WEEE as in directive 2012/19/EU) which should not be mixed with unsorted household waste. Instead, you should protect human health and the environment by handing over your waste equipment to a designated collection point for the recycling of waste electrical and electronic equipment, appointed by the government or local authorities. Correct disposal and recycling will help prevent potential negative consequences to the environment and human health. Please contact the installer or local authorities for more information about the location as well as terms and conditions of such collection points.



## 7 Warranty

---

Guangdong ePropulsion Technology Co., Ltd. ("ePropulsion"), China, warrants its products to be free of defects in material and workmanship under normal usage with proper installation and routine maintenance for a period of twenty-four (24) months from date of delivery of products to end customers (the "Limited Warranty Period"). The Limited Warranty is provided to the first end customer of ePropulsion products ONLY. The Customer is entitled to free repair or replacement of defective or non-conform parts. Any warranty claim must be made within six (6) months of discovery of issues as provided below.

If the Limited Warranty Period expires, you can still enjoy maintenance services from dealers/distributors authorized by ePropulsion (the "ePropulsion Service Partners") with minimum maintenance charge per occurrence.

In all warranty cases, ePropulsion will only bear the repair cost and other costs (such as those related to product installation, disassemble, transportation, financing, rental, etc.) as a direct result for of issues covered by the Limited Warranty only. Any costs irrelevant to or out of the scope of the Limited Warranty will be born by the Customer alone., which shall NOT include costs irrelevant such as those related to product installation, disassemble, transportation, financing, rental, etc.

Beyond the Limited Warranty, the Customer may have statutory rights in your jurisdiction according to applicable laws. Nothing in this Limited Warranty affects such rights. The Customer may have warranty claim rights arising from the purchase contract with ePropulsion Service Partners in addition to the rights granted by this Limited Warranty.

Products for commercial/professional use, even if only temporarily, are not covered by the Limited Warranty. Instead, the statutory warranty in your jurisdiction shall apply. You are encouraged to consult with ePropulsion Service Partners for applicable warranty and advice before engaging in such use.

**\* Commercial/professional Use refers to application cases that have high use frequency, high-reliability requirement or aim for money making, etc.**

To keep your warranty valid, you shall follow:

 Keep the product label intact and record the Serial Number shown on the label. Never tear the label off the product. A product without the original product label is not covered by the Limited Warranty provided by ePropulsion;

 The Limited Warranty is not transferable and will not be reissued;

 The Limited Warranty may change from time to time. Pls visit our website (<http://www.epropulsion.com>) for the latest version.

## Out of Warranty

ePropulsion may refuse a warranty claim if:

- Any improper operation contradicts what is written in the user manual;
- Accident, misuse, dropping, improper care or storage, willful abuse, physical damage, overcharging, over discharging, or unauthorized repair;
- Water ingress caused by external sources such as fishing nets, submerging underwater, etc.;
- Product modification, alternation, disassembly, or parts/accessories attachment, which are not expressly permitted or recommended by ePropulsion;
- Failure of, or damage caused by, any 3rd party products;
- Consumables are out of warranty scope (like propeller, anode...etc.);
- Purchases of product from unauthorized dealers or seller;
- Normal wear and tear and routine servicing are excluded from the warranty;
- The product gets further damaged due to improper packing during delivery. The further damaged part will be deemed as out of warranty coverage;
- Lithium battery is classified as a UN9 hazardous item, posting and packing must be in accordance with the relevant law of the local country directive. Non-compliance may result in out of warranty coverage.

## Limited Warranty Claim Procedures

The Customer shall follow the warranty claim process to make a Limited Warranty claim:

1. Contact your nearest ePropulsion Service Partners and they will provide further instruction to you if such defects are covered by the Limited Warranty or theirs.
2. Send the defective product to them together with Proof of 1(st)-time Purchase (e.g., receipt, invoice, etc., with information of product purchased and date of purchase), the Confirmation of Online Warranty Registration, ex-factory Serial Number, etc. Note that all labels shall be kept intact. The warranty is valid only when the information above is correct, genuine, and complete;
3. Make sure the product is properly packed during delivery, the original package is highly recommended.
4. The ePropulsion Service Partners will conduct diagnosis and examination on the defective products to check the validity of the warranty claim.
5. If your warranty claim is accepted, the Product or its defective components/parts will be either repaired or replaced free of charge. Note that any delivery cost incurred in the process shall be bearded by you.
6. In case your warranty claim be rejected, a repair/replace cost and fee with round trip delivery cost will be estimated and sent to you for confirmation. ePropulsion Service Partners will only begin the work after your written confirmation.



## WARRANTY CARD || ePropulsion Control System

(\*In order to validate warranty, please fill in this form first and read the Warranty Policies.)



Scan to register  
your product



Product  
tutorial

### || OWNER INFO. ||

Owner Name			
Address			
Phone		Email	

### || DEALER INFO. ||

Store Name			
Address			
Phone		Email	

### || PRODUCT INFO. ||

Date of Purchase (mm/dd/yyyy)	
Serial No.	

Thanks for reading this user manual.

If you have any concerns or find any problems while reading, please don't hesitate to contact us. We are delighted to offer service for you.

Guangdong ePropulsion Technology Limited

Webseite: [www.epropulsion.com](http://www.epropulsion.com)

E-Mail: [service@epropulsion.com](mailto:service@epropulsion.com)